



Surgical Motor Systems

Battery Operated



OPERATION
UNDER CONTROL



Battery Operated
Surgical Motor Systems

Light weight provides efficient and reliable performance with new generation powerful motor

SHARPLINE.



We Believe

Developing a creative mindset leads to innovative technologies that can change the World. Our passion is to bring products to markets that can enhance lives. One of the key ingredients to our success is having 25 years of producing and marketing experience.

What We Do

We are interested in connecting with individuals who are trying to innovate the World into a better place and willing to share creativity. If we can help in any way please feel free to e-mail us at info@sharpline.de

SHARPLINE.



Sagittal Saw System



Reciprocating Saw System



Sternum Saw System



Hexa - Function System

- Drill Mode (F&R)
- Drill Oscillation Mode
- Screwing Mode (F&R)
- Tapping Mode
- Reamer Mode (F&R)
- Reamer Oscillation Mode

SHARPX

- Light weight provides efficient and reliable cutting performance with new generation powerful motor.
- One hand piece solution for reaming, high speed drilling, screw driving and tapping functions with high torque performance.
- Lithium-ion battery technology provides consistent power during the operation.
- Easy handling and ergonomic design of SharpX ensures reliable and better controlled operation results.
- Efficient torque for acetabular reaming.
- SharpX is an innovative new generation power tool with high quality engineering materials.
- Providing efficiency with Engineering Solutions
- Extended battery life.
- Comfortable ergonomic design.
- Easy attachment assembly.
- High speed drilling and oscillating.

- Less Weight, High Power
- Next Generation Cutting Technology
- New Generation Surgical Motor Technology
- Li-ion Technology



SharpX power box records all data about usage for technical service information.



Power box oled screen enables users to indicate battery capacity by pressing the test button.



Sterile funnel

“Technical structure of *SharpX* HandPieces provides users non-restrictive washing and disifection.”



Less Weight, High Power
Next Generation Cutting Technology
New Generation Surgical Motor Technology
Li-ion Technology



SharpX provides users to observe battery level without removing the power box.



HEXA - FUNCTION SYSTEM

Six Different Trigger Functions
Weight: 1440g (Including Power Box)



SAGITTAL SAW SYSTEM

High-Low speed options
Weight: 1290g (Including Power Box)



RECIPROCATING SAW SYSTEM

High-Low speed options
Weight: 1250g (Including Power Box)



STERNUM SAW SYSTEM

High-Low speed options
Weight: 1430g (Including Power Box)

Battery Charging Units



SharpX can also provide information about battery process cycles like how many times, minutes, seconds the battery is charged, half charged or fully charged.



Power box oled screen enables users to indicate battery capacity by pressing the test button.

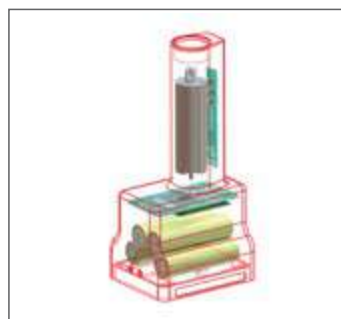

Battery, motor and all electronic components are combined together and exempt from sterilization by aim of increasing life time of the device



S-210 Power box

- Swiss made powerful DC motor technology
- Battery capacity: 2.5 Ah
- Voltage: 14.8 Volts
- Integrated oled screen audible alert notification
- Not autoclaveable
- 75 x 61 x 160 mm / 465 g



S-212 Autoclaveable sterile funnel for aseptic battery loading

- Steam sterilisable
- 30 x 74 x 104 mm / 55 g



Sterile funnel



S-226

Charger unit for 1 battery

- Main voltage 100-240 Volts, 50-60 Hz
- Charging current 2 A
- Charging voltage 16.8 Volts
- Protections: Short circuit / Overload / Over voltage
- Charging indicator led
- Battery not included
- 130 x 250 x 130 mm / 900 g



S-227

Charger unit for 2 batteries

- Main voltage 100-240 Volts, 50-60 Hz
- Charging current 2 A (x2)
- Charging voltage 16.8 Volts
- Protections: Short circuit / Overload / Over voltage
- Charging indicator led
- Battery not included
- 230 x 250 x 130 mm / 2000 g



S-229

Charger unit for 4 batteries

- Main voltage 100-240 Volts, 50-60 Hz
- Charging current 2 A (x4)
- Charging voltage 16.8 Volts
- Protections: Short circuit / Overload / Over voltage
- Charging indicator led
- Battery not included
- 430 x 250 x 130 mm / 3500 g

Drill-Reamer Handpiece



Six Different Trigger Functions

S-200
Hexa - Function System
Dual trigger system for speed control and direction control
Steam sterilisable
Cannulated Ø 4 mm
77 x 140 x 210 mm / 785 g

- Drill Mode F&R (1200 rpm)
- Drill Oscillation Mode (1200 cpm)
- Screwing Mode F&R (50 rpm)
- Tapping Mode (50 rpm)
- Reamer Mode F&R (300 rpm)
- Reamer Oscillation Mode (300 cpm)



Screwing and tapping options enable smooth control with one-handpiece solution.

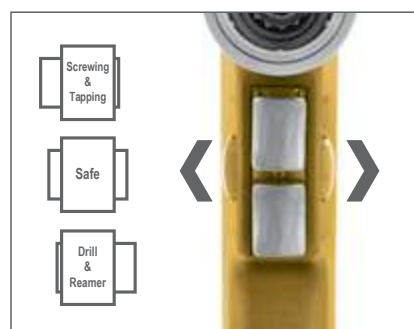

Drilling, Reaming, Screwing and Tapping options in one-handpiece



Forward, reverse and oscillation mode options provide versatile alternatives to the users.

Drill Attachments



S-308
Drill attachment with keyed chuck
Ø4 mm Cannulated
Ø 1.0 mm - 4.0 mm
1200 rpm / 5 Nm
29 x 70 mm / 140 g



S8-473
Chuck key
for S-308



S-309
Drill attachment with keyed chuck
Ø4 mm Cannulated
Ø 1.0 mm - 6.35 mm
1200 rpm / 5 Nm
29 x 87 mm / 205 g



S7-250
Chuck key
for S-309



S-311
Drill attachment with hybrid chuck
Both keyed and keyless operation
Ø4 mm Cannulated
Ø 0.3 mm - 3 mm
1200 rpm / 5 Nm
29 x 87 mm / 225 g



S7-252
Chuck key
for S-310, S-311



S-310
Drill attachment with hybrid chuck
Both keyed and keyless operation
Ø4 mm Cannulated
Ø 1.0 mm - 7.4 mm
1200 rpm / 5 Nm
34 x 100 mm / 320 g

Drills

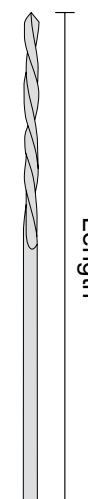

Code	(Ø) Diameter mm	Length mm
S7-500	1.5	60
S7-501	2.0	100
S7-502	2.5	100
S7-503	2.7	100
S7-504	3.0	100
S7-505	3.2	100
S7-506	3.5	100
S7-507	4.0	110
S7-508	4.5	130
S7-509	5.0	160
S7-510	6.0	160

Shank Drill Bit Attachments



S-360
Attachment for SQUARE shank
1200 rpm / 5 Nm
29 x 75 mm / 115 g

S-361
Attachment for AO shank
1200 rpm / 5 Nm
29 x 73 mm / 125 g

S-362
Attachment for TRINKE shank
1200 rpm / 5 Nm
29 x 70 mm / 130 g

Drills

L Length mm	Ø Diameter mm	SQUARE	AO	TRINKE
38	1.5	S7-520	S7-540	S7-560
45	2.0	S7-521	S7-541	S7-561
53	2.5	S7-522	S7-542	S7-562
57	2.7	S7-523	S7-543	S7-563
57	3.0	S7-524	S7-544	S7-564
57	3.2	S7-525	S7-545	S7-565
65	3.5	S7-526	S7-546	S7-566
70	4.0	S7-527	S7-547	S7-567
70	4.5	S7-528	S7-548	S7-568
95	5.0	S7-529	S7-549	S7-569
120	6.0	S7-530	S7-550	S7-570

S-375
Attachment for OSTEO shank
Ø4 mm Cannulated
300 rpm / 22 Nm
29 x 78 mm / 160 g

S-376
Attachment for DHS shank
Ø4 mm Cannulated
300 rpm / 22 Nm
29 x 100 mm / 170 g

S-377
Attachment for AO-PROTEK shank
Ø4 mm Cannulated
300 rpm / 22 Nm
29 x 82 mm / 210 g

S-378
Attachment for HUDSON shank
Ø4 mm Cannulated
300 rpm / 22 Nm
29 x 68 mm / 145 g

S-379
Attachment for HARRIS shank
Ø4 mm Cannulated
300 rpm / 22 Nm
29 x 102 mm / 145 g

S-380
Attachment for ZIMMER-HUDSON shank
Ø4 mm Cannulated
300 rpm / 22 Nm
29 x 115 mm / 155 g

S-381
Attachment for ZIMMER shank
Ø4 mm Cannulated
300 rpm / 22 Nm
29 x 115 mm / 155 g

Reamer Attachment

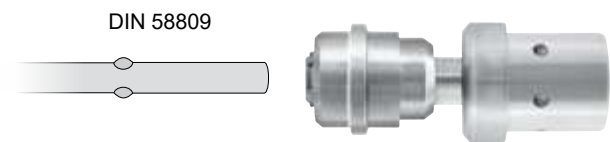

S-330
Reamer attachment for wire and pin
Cannulated Ø 4 mm
300 rpm / 22 Nm
29 x 80 mm / 185 g



S7-905
Adaptor for AO-Protek shank
Cannulated Ø 4 mm



S7-908
Adaptor for Hudson
Cannulated Ø 4 mm



S7-907
Adaptor for Harris
Cannulated Ø 4 mm



S7-906
Universal three-jaw chuck
with key S7-250
Max Ø 6.35 mm
Cannulated Ø 4 mm



S7-250
Chuck key
for S7-906

Intramedullary reamers, flexible, with drilling heads		Guides, blunt			Guides, with drill tip		
Ø mm	Length 430 mm	Ø mm	Length 600 mm	Length 990 mm	Ø mm	Length 600 mm	Length 990 mm
5.5	S7-920						
6.0	S7-921						
6.5	S7-922	1.9	S7-960	S7-961	1.9	S7-962	
7.0	S7-923						
7.5	S7-924						
8.0	S7-925						
8.5	S7-926						
9.0	S7-927						
9.5	S7-928						
10.0	S7-929						
10.5	S7-930						
11.0	S7-931						
11.5	S7-932						
12.0	S7-933	3.4	S7-963	S7-964	3.4		S7-965
12.5	S7-934						
13.0	S7-935						
13.5	S7-936						
14.0	S7-937						
14.5	S7-938						
15.0	S7-939						
15.5	S7-940						
16.0	S7-941						
16.5	S7-942						
17.0	S7-943						
17.5	S7-944						
18.0	S7-945						
18.5	S7-946						
19.0	S7-947						

Acetabular Reamer Attachment

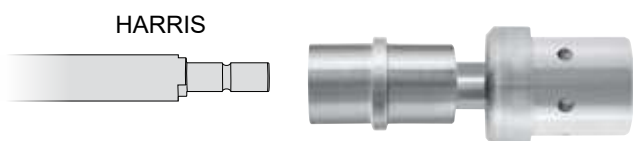

S-320
Acetabular reamer attachment
150 rpm / 35 Nm
29 x 80 mm / 175 g

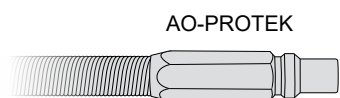

S7-705
Adaptor for AO-Protek shaft

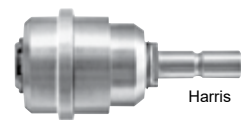
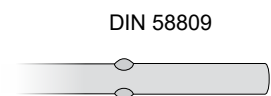

S7-706
Adaptor for DIN 58809 shaft

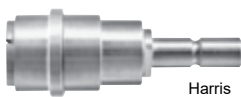
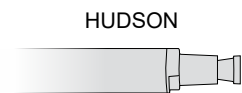

S7-707
Adaptor for Hudson shaft



S7-708
Universal three-jaw chuck
with key S7-250



S7-250
Chuck key
for S7-708



S7-709
Shaft only,
With Harris Connection
for S7-750, S7-757



S7-789
Movable protector case,
Fits with all reamer shafts

Only Acetabular Reamer	S7-750	Ø 46 mm
	S7-751	Ø 48 mm
	S7-752	Ø 50 mm
	S7-753	Ø 52 mm
	S7-754	Ø 56 mm
	S7-755	Ø 60 mm
	S7-756	Ø 64 mm
	S7-757	Ø 68 mm



Quick - action chuck (K-wire Driver)



S-352
Quick - action chuck (K-wire Driver)
Cannulated Ø 0.7 mm - 2.5 mm
1200 rpm / 5 Nm
29 X 77 mm / 300 g

S-353
Quick - action chuck (K-wire Driver)
Cannulated Ø 1.5 mm - 4.0 mm
1200 rpm / 5 Nm
29 X 77 mm / 300 g

Reciprocating Saw System



S-235
Reciprocating saw system
(Without saw blades and power box)

- High-Low speed options
- Steam sterilisable
- 11.000 - 14.000 cpm / \leftrightarrow 4 mm
- 77 X 180 x 210 mm / 860 g



S103-236
Usable length: 62 mm
Width: 8 mm



S103-237
Usable length: 75 mm
Width: 13 mm



S103-238
Usable length: 60 mm
Width: 13 mm



S103-239
Usable length: 75 mm
Width: 13 mm

Sagittal Saw System



S-300
Sagittal saw system
(Without saw blades and power box)

- High-Low speed options
- Steam sterilisable
- 10.000 - 12.000 cpm / $\angle 4^{\circ} 50'$
- 77 x 153 x 218 mm / 850 g

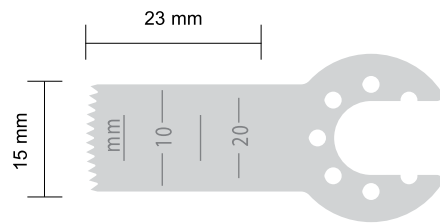

S103-1110
Material Thickness: 0.4 mm
Cutting Thickness: 0.6 mm

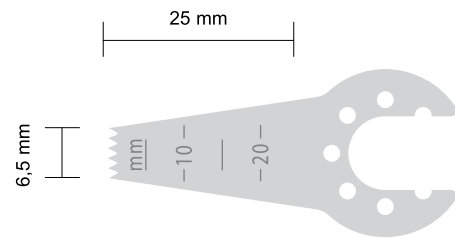

S103-1111
Material Thickness: 0.4 mm
Cutting Thickness: 0.6 mm

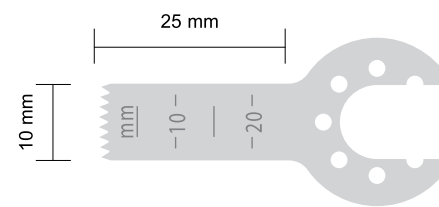

S103-1112
Material Thickness: 0.4 mm
Cutting Thickness: 0.6 mm

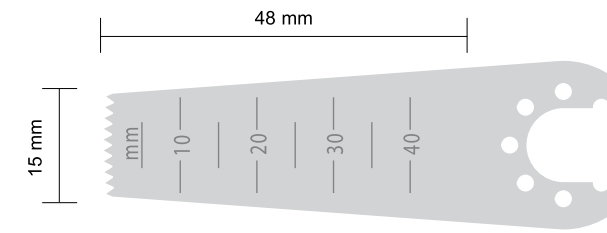

S103-1113
Material Thickness: 0.4 mm
Cutting Thickness: 0.6 mm

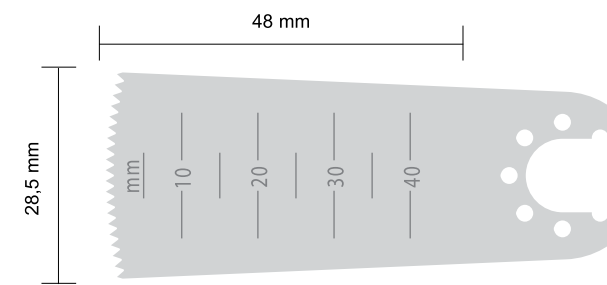

S103-1114
Material Thickness: 0.4 mm
Cutting Thickness: 0.6 mm

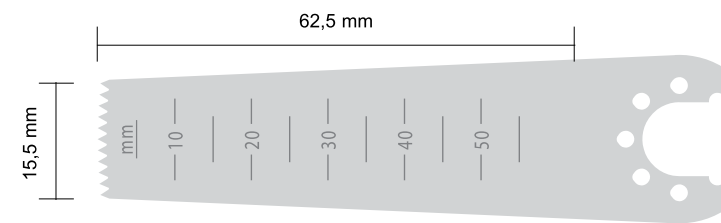

S103-1115
Material Thickness: 0.6 mm
Cutting Thickness: 0.8 mm

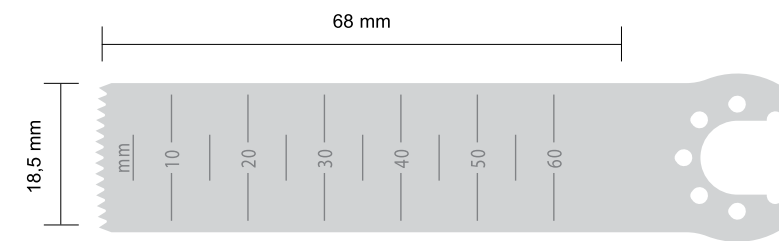

S103-1116
Material Thickness: 0.6 mm
Cutting Thickness: 0.8 mm

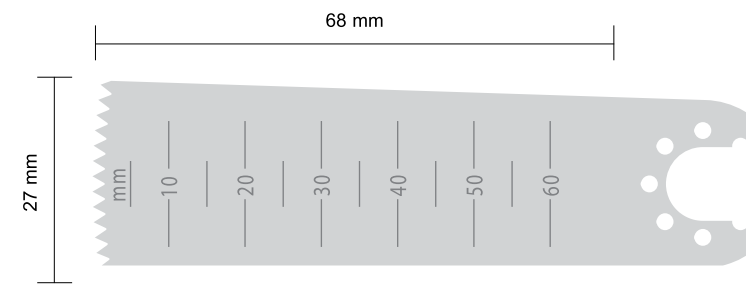

S103-1117
Material Thickness: 0.6 mm
Cutting Thickness: 0.8 mm

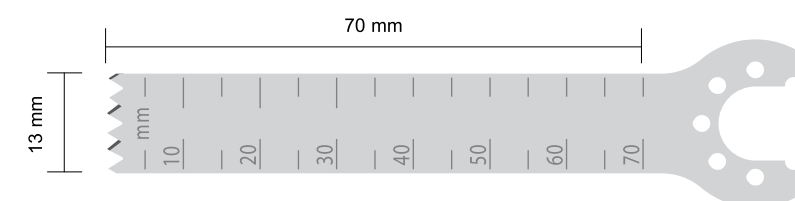

S103-1118
Material Thickness: 1.19 mm

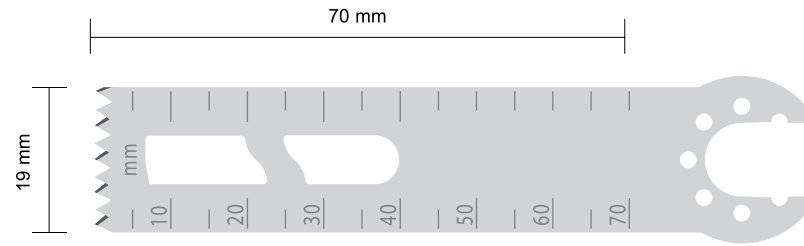

S103-1119
Material Thickness: 1 mm

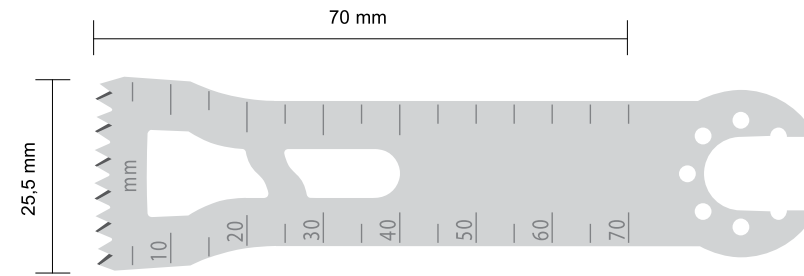

S103-1120
Material Thickness: 1 mm

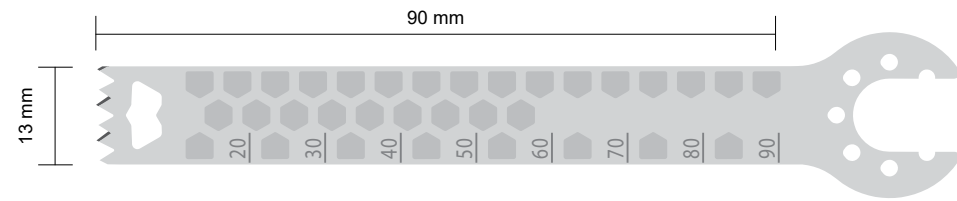

	Material Thickness
S103-1121	1 mm
S103-1122	1.19 mm
S103-1123	1.27 mm
S103-1124	1.37 mm

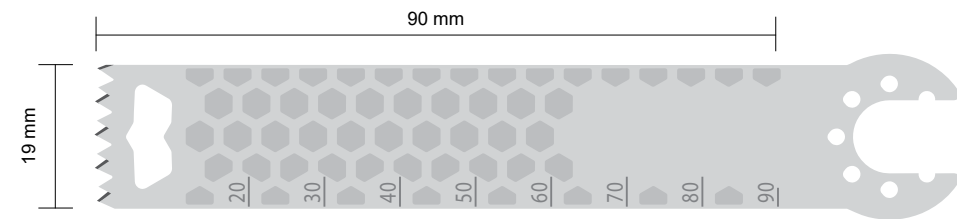

	Material Thickness
S103-1125	1.19 mm
S103-1126	1.27 mm
S103-1127	1.37 mm

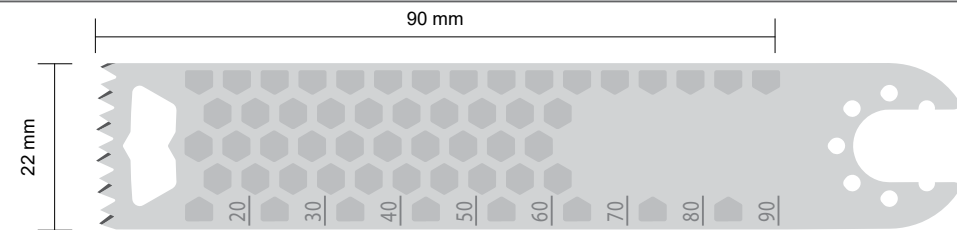

	Material Thickness
S103-1128	1 mm
S103-1129	1.19 mm
S103-1130	1.27 mm
S103-1131	1.37 mm
S103-1132	1.47 mm

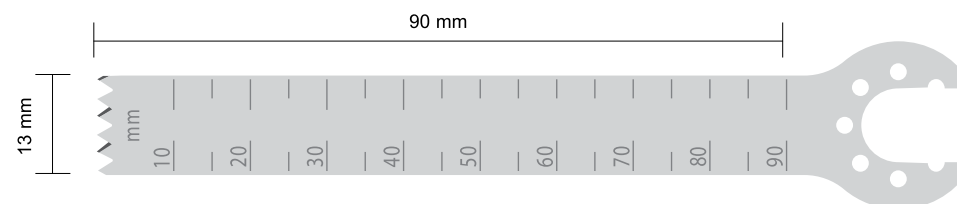

	Material Thickness
S103-1133	1 mm
S103-1134	1.19 mm
S103-1135	1.27 mm

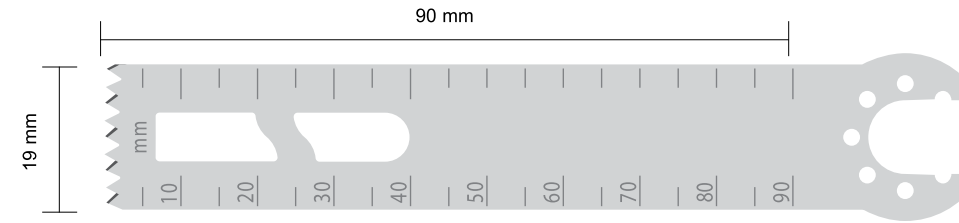

	Material Thickness
S103-1136	1.27 mm
S103-1137	1.37 mm

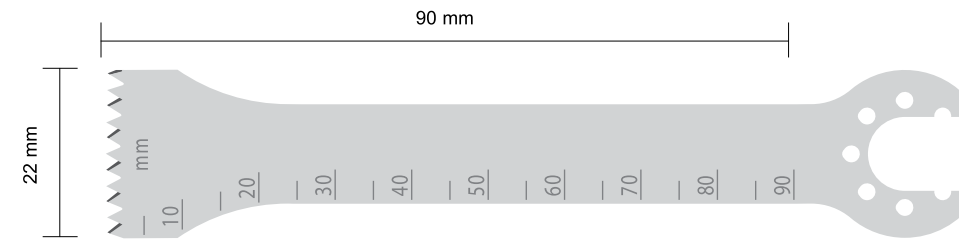

S103-1138
Material Thickness: 1.27 mm

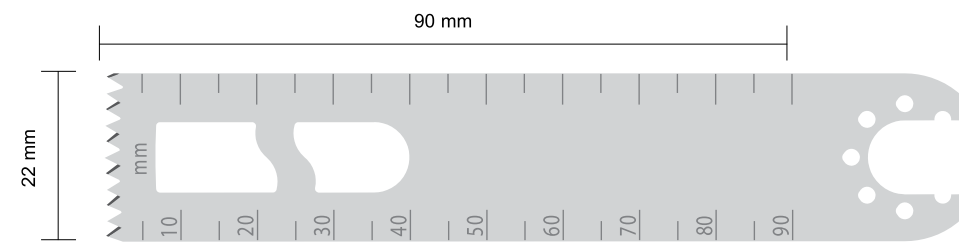

	Material Thickness
S103-1139	1 mm
S103-1140	1.27 mm

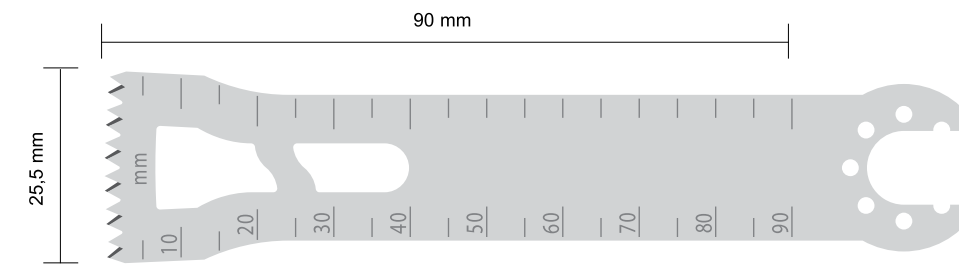

	Material Thickness
S103-1141	1 mm
S103-1142	1.19 mm
S103-1143	1.27 mm
S103-1144	1.37 mm
S103-1145	1.47 mm

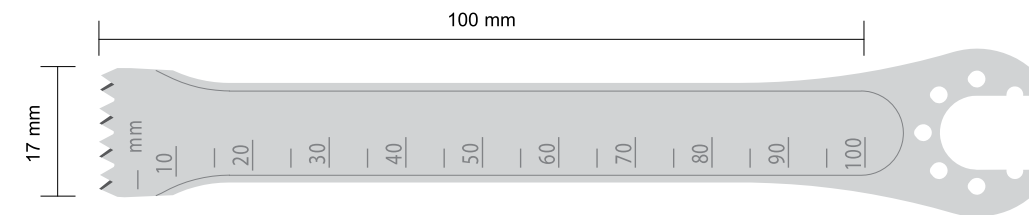

S103-1146
Material Thickness: 1.27 mm

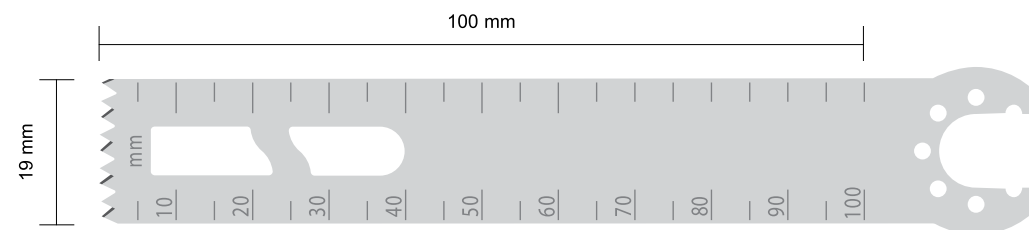

S103-1147
Material Thickness: 1.19 mm

Sternum Saw System





S-240
Sternum saw system
(Without saw blades, guide and power box)

- High-Low speed options
- Steam sterilisable
- 11.000 x 14.000 cpm / \leftrightarrow 4 mm
- 77 x 180 x 210 mm / 930 g





S103-715
Adult saw guide

Adult saw blade	Code	Length	Usable Length	Blade Thickness	Cutting Thickness
	S103-709	58 mm	35 mm	0,6 mm	1 mm
	S103-710	58 mm	35 mm	0,8 mm	1,2 mm



S103-716
Pediatric saw guide

Pediatric saw blade	Code	Length	Usable Length	Blade Thickness	Cutting Thickness
	S103-711	40 mm	18 mm	0.6 mm	0.6 mm
	S103-712	40 mm	18 mm	0.6 mm	0,8 mm

Re-Operation Oscillating Saw System



S-300
Oscillating saw system
(Without saw blades and power box)

- High-Low speed options
- Steam sterilisable
- 10.000 x 12.000 cpm / \angle 4° 50'
- 77 x 180 x 210 mm / 850 g

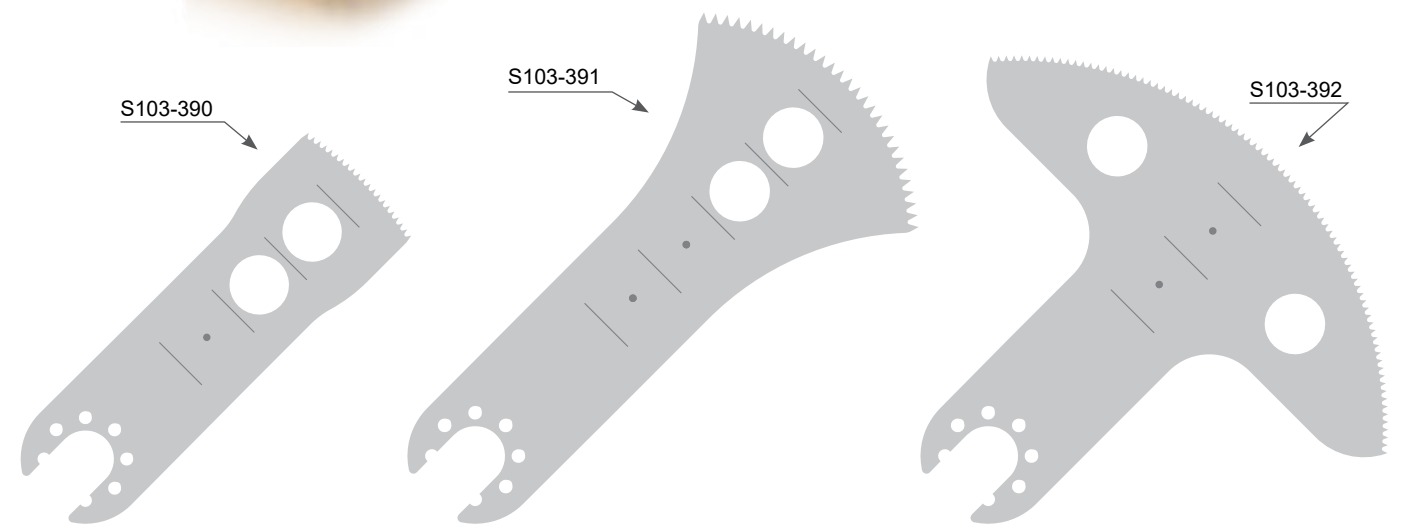

Code	Length	Width	Thickness
S103-390	35 mm	25 mm	0.8 mm
S103-391	50 mm	40 mm	0.8 mm
S103-392	35 mm	75 mm	0.8 mm

Orthopedic Set



S-1001 Orthopedic Set

Set Content

S-200	Sharpx Drill-Reamer Handpiece
S-210	Power box (2 pcs)
S-212	Autoclaveable sterile funnel for aseptic battery loading
S-227	Charger unit for 2 battery
S-309	Drill attachment with keyed chuck
S7-502	Drill bit
S7-504	Drill bit
S7-250	Chuck key for S-309
S-300	Sharpx Sagittal saw Handpiece
S103-1117	Sagittal saw blade
S103-1146	Sagittal saw blade
S-320	Acetabular reamer attachment
S-330	Reamer attachment for wire and pin
S-352	Quick - action chuck (K-wire Driver)
S8-510	Sprey oil
S3-2723	Basket with silicone fixations 540 x 253 x 113 mm
01.11.15B	Standard Model Container 600 x 285 x 155 mm



S-210
Power box
(2 pcs)



S-227
Charger unit for 2 batteries



S8-510
Sprey oil, for motor and additional pcs.
After cleaning of every use. Oil inside of all moving pcs of device by spraying method and run the device for 2-3 seconds.



S3-2723
Basket with silicone fixations
540 x 253 x 113 mm

01.11.15B

Standard Model Container
Box (non perforated) Lid perforated
600 x 285 x 155 mm



Drill Set



S-1005 Drill Set

Set Content

S-200	Sharpx Drill-Reamer Handpiece
S-210	Power box
S-212	Autoclaveable sterile funnel for aseptic battery loading
S-226	Charger unit for 1 battery
S-309	Drill attachment with keyed chuck
S7-502	Drill bit
S7-504	Drill bit
S7-250	Chuck key for S-309
S8-510	Sprey oil
S3-2731	Basket with silicone fixations 405 x 253 x 113 mm
01.34.15	Standard Model Container 475 x 285 x 155 mm



S-210
Power box



S-226
Charger unit for 1 battery



S8-510
Sprey oil, for motor and additional pcs.
After cleaning of every use. Oil inside of all moving pcs of device by spraying method and run the device for 2-3 seconds.



S3-2731
Basket with silicone fixations
405 x 253 x 113 mm

01.34.15

Standard Model Container
Box (non perforated) Lid perforated
475 x 285 x 155 mm



Sagittal Saw Set



S-1007 Sagittal Saw Set	
Set Content	
S-300	Sharpx Sagittal saw Handpiece
S-210	Power box
S-212	Autoclaveable sterile funnel for aseptic battery loading
S-226	Charger unit for 1 battery
S103-1117	Sagittal saw blade
S103-1146	Sagittal saw blade
S8-510	Sprey oil
S3-2731-S2	Basket with silicone fixations 405 x 253 x 113 mm
01.34.15	Standard Model Container 475 x 285 x 155 mm



S-210
Power box



S-226
Charger unit for 1 battery



S8-510
Sprey oil, for motor and additional pcs.
After cleaning of every use. Oil inside of all moving pcs of device by spraying method and run the device for 2-3 seconds.



01.34.15
Standard Model Container
Box (non perforated) Lid perforated
475 x 285 x 155 mm



S3-2731-S2
Basket with silicone fixations
405 x 253 x 113 mm

Reciprocating Saw Set



S-1013 Reciprocating Saw Set	
Set Content	
S-235	Sharpx Reciprocating saw Handpiece
S-210	Power box
S-212	Autoclaveable sterile funnel for aseptic battery loading
S-226	Charger unit for 1 battery
S103-239	Reciprocating saw blade
S8-510	Sprey oil
S3-2731-S3	Basket with silicone fixations 405 x 253 x 113 mm
01.34.15	Standard Model Container 475 x 285 x 155 mm



S-210
Power box



S-226
Charger unit for 1 battery



S8-510
Sprey oil, for motor and additional pcs.
After cleaning of every use. Oil inside of all moving pcs of device by spraying method and run the device for 2-3 seconds.



01.34.15
Standard Model Container
Box (non perforated) Lid perforated
475 x 285 x 155 mm



S3-2731-S3
Basket with silicone fixations
405 x 253 x 113 mm

Sternal Saw Set



S-1009 Sternal Saw Set

Set Content	
S-240	Sharpx Sternum saw Handpiece
S-210	Power box
S-212	Autoclaveable sterile funnel for aseptic battery loading
S-226	Charger unit for 1 battery
S103-715	Adult saw guide
S103-710	Adult saw blade
S8-510	Sprey oil
S3-2731-S4	Basket with silicone fixations 405 x 253 x 113 mm
01.34.15	Standard Model Container 475 x 285 x 155 mm



S-210
Power box



S-226
Charger unit for 1 battery



S8-510
Sprey oil, for motor and additional pcs.
After cleaning of every use. Oil inside of all moving pcs of device by spraying method and run the device for 2-3 seconds.



S3-2731-S4
Basket with silicone fixations
405 x 253 x 113 mm



01.34.15
Standard Model Container
Box (non perforated) Lid perforated
475 x 285 x 155 mm

Cardio Vascular Set

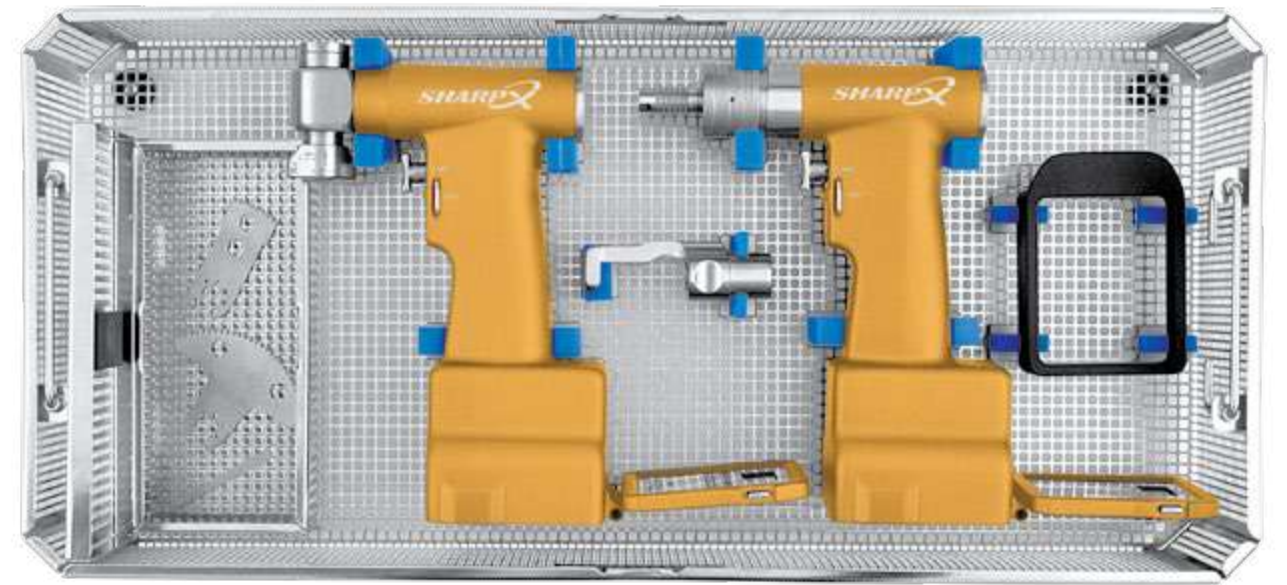

S-1011 Cardio Vascular Set

Set Content	
S-240	Sharpx Sternum saw Handpiece
S-210	Power box (2 pcs)
S-212	Autoclaveable sterile funnel for aseptic battery loading
S-227	Charger unit for 2 battery
S-300	Sharpx Re-Operation saw Handpiece
S103-715	Adult saw guide
S103-710	Adult saw blade
S103-392	Re-Operation saw blade
S8-510	Sprey oil
S3-2723-S2	Basket with silicone fixations 540 x 253 x 113 mm
01.11.15B	Standard Model Container 600 x 285 x 155 mm



S-210
Power box
(2 pcs)



S-227
Charger unit for 2 batteries



S8-510
Sprey oil, for motor and additional pcs.
After cleaning of every use. Oil inside of all moving pcs of device by spraying method and run the device for 2-3 seconds.



S3-2723-S2
Basket with silicone fixations
540 x 253 x 113 mm



01.11.15B
Standard Model Container
Box (non perforated) Lid perforated
600 x 285 x 155 mm

SHARPLINE.

0(151) 242 73 684
+90 (362) 447 02 00

3rd floor Rotebuehlplatz 23, City Plaza, Stuttgart,
Baden-Württemberg, 70178, Germany

Hancerli Mh. Derviszade Sk. No:6/4 Samsun/Turkey

info@sharpline.de
sharpline.de